

MICROFLAT SERIES

TYPES C...F S...F

M...F T...F

AUTOMATIC CONTROL SYSTEMS FOR GAS BURNERS AND GAS BURNING APPLIANCES WITH OR WITHOUT FAN AND WITH BUILT-IN ANTI-EMISSIONS FILTER

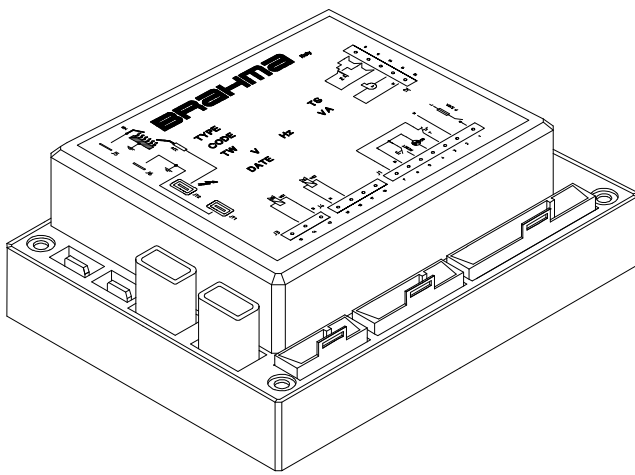

APPLICATION

This range of electronic gas burner control systems has been specifically designed for atmospheric burners for intermittent operation (systems for non-permanent operation), with or without fan in the combustion circuit.

These controls are provided with both non-volatile lockout and volatile lockout: in the first case restart from the safety shutdown condition can only be accomplished by a manual reset of the system; in the second case restart from the safety shutdown condition can only be accomplished by an interruption of the main power and its subsequent restoration.

The automatic burner control units of this series are suitable for:

- combi boilers;
- heating boilers;
- warm air generators;
- radiant heaters;
- water heaters.

Thanks to their design and variety of models, they can also be used for the automation of ovens, cookers and in gas firing installations with atmospheric burner in general.

FEATURES

Table 1 shows the main features of this series. Other important features are:

- **EC certification** (CE Reg. N°0694BP0669) in accordance with Gas Appliance Directives 90/396 and 93/68;
- in accordance with EN 298 (European standard for automatic gas burner control systems and flame detectors);
- completely solid and high efficient inbuilt ignition device with built-in **E.M. filter**;
- possibility of mounting a resistor ($0 \div 220$ ohm) in series to the valve output, in case the valves operate with direct current obtained through the rectification of the supply alternate current by means of one or more diodes.
This resistor allows to reduce electromagnetic disturbances generated by diodes switching;
- possibility of mounting a resistor ($0 \div 470$ Kohm) in series to the lockout signal output, to avoid possible damages to the control in case the connections of the reset button and the connections of the lockout signal are inverted;
- two independent safety contacts in series on the gas valve output (only for non-volatile lockout types);
- auxiliary contact for low power ignition or main gas valve control for intermittent pilot systems; this contact is not isolated from the main supply voltage by reinforced isolation, therefore the relay contact is not suitable to supply SELV circuits - Safety Extra Low Voltage, e.g.24V;
- flame monitoring by the rectification property of the flame (ionization).

Table 1

	Burner						Features						
	Non-volatile lockout	Volatile lockout	Single flame	Dual flame	Atmospheric without fan	Atmospheric with fan	Monoelectrode	Auxiliary contact ①	Safety thermostat provision ②	Connector type molex ③	According to EN 298 :1993	According to EN 298 :2003 ⑤	Classification code according to EN 298 ④
CM11F	*		*		*					*	*	*	AMCLXN
CM12F	*		*	*	*					*	*	*	ATCLXN
CM31F	*		*		*					*	*	*	FMCLXN
CM32F	*		*	*	*	*				*	*	*	FTCLXN
SM11F	*		*		*		*			*	*	*	ATCLXN
SM31F	*		*	*	*	*	*			*	*	*	FTCLXN
MM11F	*		*		*		*			*	*	*	AMCLXN
MM12F	*		*	*	*	*	*			*	*	*	ATCLXN
MM51F	*		*	*	*	*	*			*	*	*	ATCLXN
MM31F	*		*		*	*	*			*	*	*	FMCLXN
MM32F	*		*	*	*	*	*			*	*	*	FTCLXN
TM11F	*		*		*		*			*	*	*	AMCLXN
TM12F	*		*	*	*	*	*			*	*	*	ATCLXN
TM31F	*		*		*	*	*			*	*	*	FMCLXN
TM32F	*		*	*	*	*	*			*	*	*	FTCLXN
CE11F	*	*	*	*	*	*	*			*	*	*	AMCVXN
CE12F	*	*	*	*	*	*	*			*	*	*	ATCVXN
CE31F	*	*	*	*	*	*	*			*	*	*	FMCVXN
CE32F	*	*	*	*	*	*	*			*	*	*	FTCVXN
SE11F	*	*	*	*	*	*	*			*	*	*	ATCVXN
SE31F	*	*	*	*	*	*	*			*	*	*	FTCVXN
ME11F	*	*	*	*	*	*	*			*	*	*	AMCVXN
ME12F	*	*	*	*	*	*	*			*	*	*	ATCVXN
ME51F	*	*	*	*	*	*	*			*	*	*	ATCVXN
ME31F	*	*	*	*	*	*	*			*	*	*	FMCVXN
ME32F	*	*	*	*	*	*	*			*	*	*	FTCVXN
TE11F	*	*	*	*	*	*	*			*	*	*	AMCVXN
TE12F	*	*	*	*	*	*	*			*	*	*	ATCVXN

NOTE

- ① This contact is not isolated from the main supply voltage by reinforced isolation, therefore the relay contact is not suitable to supply SELV circuits – Safety Extra Low Voltage.
- ② Safety thermostat opening causes cycle repetition and volatile/non-volatile lockout.
- ③ Standard connectors are Stelvio-Stocko models, as shown in Fig.2.
- ④ Flame failure during TS causes spark restoration.
- ⑤ Device is compliant only if the note “EN 298:2003 compliant” and the option “#” are reported on the label.

TECHNICAL DATA

Supply voltage: 220/240V @ 50/60Hz
 On request: 110/120V @ 50/60Hz
Operative temperature range: -20°C ÷ +60°C
Ambient humidity: 95% MAX @ 40°C
Protection degree: IP 00

Times:

- prepurge or waiting time (**TW**): 1.5 ... 40 s
- safety time (**TS**): 3 ... 120 s
- response time on running flame failure (**TR**): < 1 s

The times given on the burner control label correspond to the values guaranteed. The actual values slightly differ from the values given, pre-purge and waiting time is in fact longer and safety time shorter than their nominal values.

Power consumption, at starting up:

- types without burner 10VA
- types with burner 12VA

Power consumption, running:

- types without burner 7VA
- types with burner 9VA

Contact rating:

- Thermostat: 4A cosφ ≥ 0.4
- VG1: 0.5A cosφ ≥ 0.4
- VG2: 0.5A cosφ ≥ 0.4
- Fan motor: 1A cosφ ≥ 0.4
- Lock-out signalling: 1A cosφ = 1
- Auxiliary contact: 0.5A cosφ ≥ 0.4

Max. length of the cables of external components:

1 m

Internal fuse rating:

4A fast

External fuse rating:

3.15A fast

Flame control:

The ionization flame detection device makes use of the rectification property of the flame.

The ionization flame detector device is not safe to touch output (no provision with protective impedances).

- Minimum ionization current: 0.5µA
 on request: 1.2µA / 2.5µA
- Max ionization current @ 230V: 8.5µA DC
- Recommended ionization current: 3÷5 times the minimum value
- Max. length of the cable: 1 m
- Minimum insulation resistance of the cable and the flame detector device to earth: ≥ 50 MΩ
- Max. parasitic capacitance of the detection probe: ≤ 1 nF
- Max. short circuit current: < 200µA AC

Ignitor:

- Peak ignition voltage: 15KV con carico di 30pF
on request: 12/18 KV
 - Peak current: 800 mA
 - Spark repetition rate: 25 Hz
on request: 1 ... 8/10/12/16 Hz
 - Max. length of the cable: 2 m
 - Spark gap recommended: 2-4 mm
 - Consumption: 2.5 VA
 - Spark energy: 20 mJ
- Weight:** 170 g

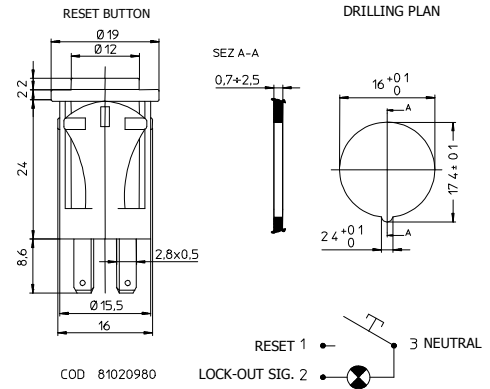

CONSTRUCTION

The enclosure made of plastic material and the varnishing of the circuit board protect the control from mechanical damages, dust and dirt from the conditions of installation. Through the use of a board assembled with surface mounted components and of a new **patented** circuit generating the ignition spark which limits the EM to a minimum, it has been possible to reduce the printed circuit board dimensions and to realize even the most complex executions with extremely compact dimensions. A varistor protects the control from voltage transient on the main supply, caused for example by discharges such as thunderbolts. An internal fuse protects the relays of the control box in case of short circuits on the outputs (valves, fan and lockout signal). In any case the control must be protected with a fast blow external fuse suitable to the load connected and never exceeding 3.15 A.

OVERALL DIMENSIONS

The control units of the MICROFLAT series can be supplied in different executions but with the same enclosure. The following figure (Fig. 1) shows the overall dimensions of the controls.

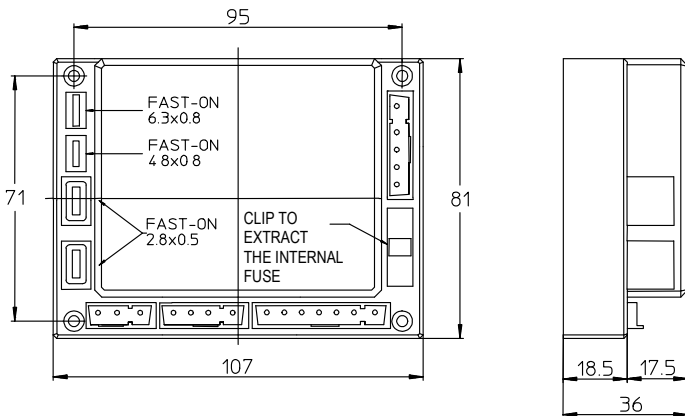

Fig. 1

POSSIBLE FIXING

- | | | | |
|---------|----------------------------------------------------------------|------------------------|------------------|
| top: | self-tapping screw
M3x22 screw | UNI 6951AB
UNI6107 | 2,9x22 |
| bottom: | Screwplast self-forming screw
Screwplast self-forming screw | ISO0003 F
ISO0003 F | 3.5x13
3.9x13 |

ACCESSORI

The control units are usually supplied with a kit of female connectors and/or a reset button (see Fig.2 and Fig.3). Do not fit terminals and female connectors of different types.

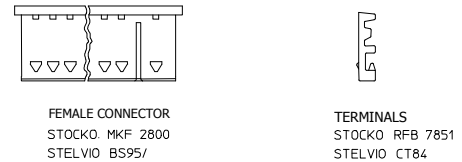

Fig. 2

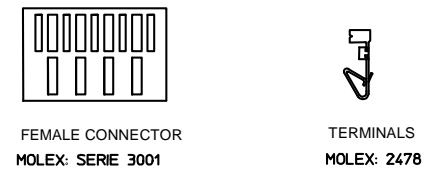

Fig. 3

CONNECTION

The use of non-reversible connectors with a different number of poles makes the connection easy and reliable. One-way fast-on connectors of different sizes for ignition and detection electrodes permit their easy installation and replacement. The dual output ignition device allows spark generation on one point (3a), two points (3b) or between two electrodes isolated from the metal frame of the burner (3c), see Fig.4. The configuration (3c) assures a limited EM emission.

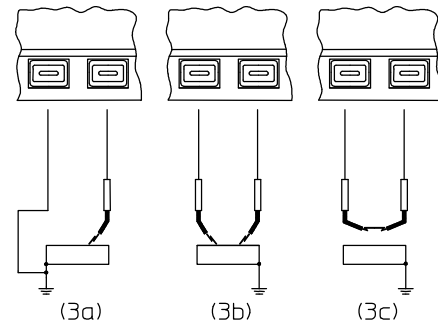

Fig. 4

Provisions such as strain relieves, sufficient earth terminals and neutral terminals should be present in the appliance or in external connection boxes. With all types it is possible to execute the connection with a J3 connector as shown in Fig.5. Types TM..F are prearranged for the connection of a safety thermostat ST which stops the supply to the gas valve VG1 and causes a safety shutdown after a delay which is the sum of waiting (pre-purge) and safety times.

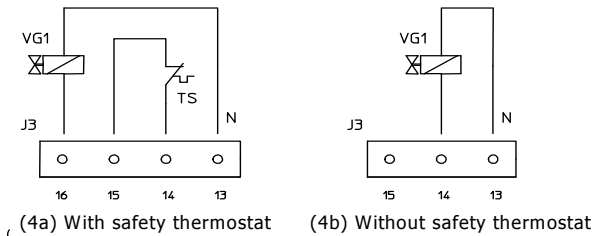

Fig. 5

DIRECTIONS FOR USE

- For technical and safety reasons a regulation shutdown must occur every 24 hours (systems for non-permanent operation);
- automatic controls are safety devices and must not be opened. The manufacturer's responsibility and guarantee are invalidated if the control is opened;
- the control must be connected and disconnected only after switching off the main power;
- the control can be mounted in any position;
- avoid exposing the control unit to dripping water;
- ventilation and the lowest temperature ensures the longest life of the control;
- make sure that the type (code and times) you are using is correct before installing or replacing the control;
- the gas appliance on which the control is installed must provide adequate protection against the risk of electrical shock (at least IP20).

ELECTRICAL INSTALLATION

- The applicable national regulation and the European standards (e.g. EN 60335-1/prEN 50165) regarding electrical safety must be respected;
- **live** and **neutral** should be connected correctly, a mistake could cause a dangerous situation, i.e. the valves would still be live with the thermostats and limits switched off. If **live-neutral** polarity is not respected the control performs a non-volatile lockout at the end of the safety time at starting up;
- before starting the system check the cables carefully. Wrong connections can damage the control and compromise the safety;
- the **earth** terminal of the control, the metal frame of the burner and the earth on the main supply must be well connected;
- avoid putting the detection cable close to power or ignition cables;
- use a heat resistant cable for the detection probe, well insulated to the **ground** and protected from possible moisture (or water in general);
- use an ignition cable as short and straight as possible and keep it far from other conductors to reduce the emission of interference (max.length <2m and insulation voltage >25KV).

In case of **live-neutral** network with unearthed **neutral** or **live-live** network (with centre of the star not earthed) the control can operate correctly by means of a built-in resistor. In case of "partial" short circuits or bad insulation between **live** and **earth** the voltage on the ionization probe can be reduced until it causes the lockout of the control, because of the impossibility of detecting the flame signal.

In the presence of this kind of network it is advisable to use our step-up transformer type AR1.

CHECKING AT START

Always check the control before the first start and also after any substitutions or a long period of non-operation of the system. Before any ignition attempt make sure that the combustion chamber is free from gas.

Then make sure that:

- if the starting attempt occurs without gas supply the control performs a non-volatile lockout after TS;
- when stopping the gas flow while the control is in running state the supply to the gas valve is interrupted within 1 second, and after a recycling the control proceeds to a non-volatile lockout;
- operating times and sequence are suitable;
- the level of the flame signal is sufficient, see Fig.6 for the measuring test;
- the ignition probe(s) is (are) adjusted in the most stable way for a spark gap between 2-4 mm;
- the intervention of limiters or safety devices causes a safety shutdown according to the application.

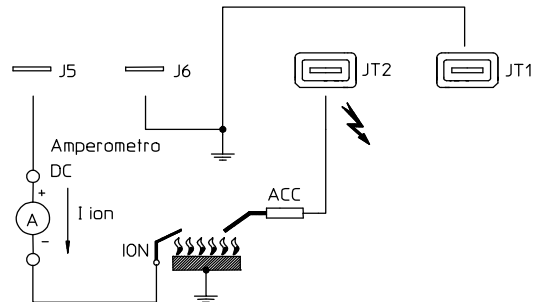

Fig. 6

OPERATION

At every start the control unit proceeds to a self-checking of its own components. During the waiting or prepurge time (TW) the operation of the flame signal amplifier is checked: the internal circuit makes a test of the flame signal amplifier circuit. A parasitic flame signal or a fault in the amplifier prevent the control from starting.

In the types with fan control, before the elapsing of the prepurge time, the air pressure switch contacts are checked to prove their "no air flow" state.

Only if the test is positive the fan is started and with the air pressure switch in "air flow" state the prepurge time begins. At the end of the waiting or prepurge time the VG1 gas valve is energized and the ignition device is operated. In this way the safety time (TS) begins. If the presence of flame is detected during the safety time the ignition device is inhibited and, in the suitable models, the main valve (VG2) is supplied or the independent auxiliary contact will switch from off to flame detected position.

On the contrary, if the control detect no presence of flame by the end of TS, it proceeds to non-volatile lockout, the VG1 gas valve and the ignition device are switched off while the lockout signal output is supplied.

Flame failure during the safety time causes the ignition device to be activated within one second.

The attached diagrams are useful to understand how each control operates.

NON-VOLATILE LOCKOUT - RESET OF THE CONTROL

When a control has gone to non-volatile lockout, a ten-second delay should be allowed before attempting to reset the control unit; if this time is not observed the control may not reset correctly.

VOLATILE LOCKOUT – RESET OF THE CONTROL

The restart from the safety shut-down condition can only be accomplished by an interruption of the main power and its subsequent restoration.

This types of burner control units do not contain an independent manual reset function. The application of these types of controls is therefore restricted to only those appliances where resetting by switching off the heat demand is allowed by European standards.

In general, resetting of the appliance must occur in sight and in the near vicinity of the appliance. Resetting must also occur by means of a conscious manual action and not by means of automatic device like thermostats or timers. Please note that it is allowed to combine the reset button together with the main switch on the appliance. In this case the alarm light will have to be installed too.

CONTROLS DENOMINATION

Type					Options								
(1)	(2)	(3)	(4)	F	(5)	(6)	(7)	(8)	(9)	(10)	(11)	(12)	(13)
<u>Types description</u>													
(1) Installations													
C Wall boilers													
S General uses													
M Monoelectrode													
T With safety thermostat													
(2) Reset													
M Manual													
E Electrical													
(3) Type of burner													
1 Without fan													
3 With fan													
5 Special types													
(4) Gas valves													
1 Single flame													
2 Dual flame													
<u>Options description</u>													
(5) Compliance													
According to EN 298:1993													
# According to EN 298:2003													
(6) Kind of connectors													
Stocco-Stelvio connectors													
X Molex connectors													
(7) Internal fuse													
Not-accessible internal fuse													
F Accessible internal fuse													
(8) Resistor in series with VG2													
Not present													
W Present													
(9) Resistor in series with VG1													
Not present													
V Present													
(10) Protection against the inversion of the connections of the lockout signal and the connections of the reset button													
Not present													
R Present													
(11) Protection against air pressure switch reversal connection													
Not present													
P Present													
(12) Ignition coltage													
15 Kv (standard)													
H 18 kV													
L 12 kV													
(13) Spark repetition rate													
25 Hz (standard)													
nn Number represents the discharge frequency													

CONNECTION DIAGRAM

TYPES WITH MANUAL RESET WITHOUT FAN

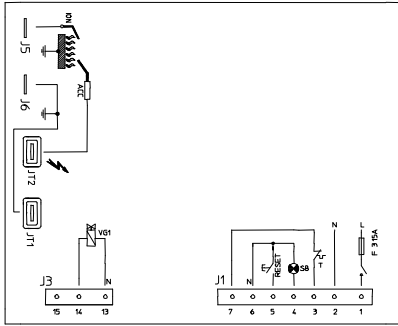

TYPE CM11F

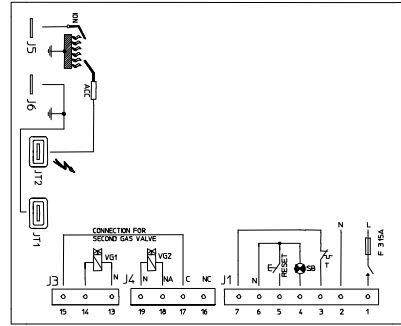

TYPE SM11F

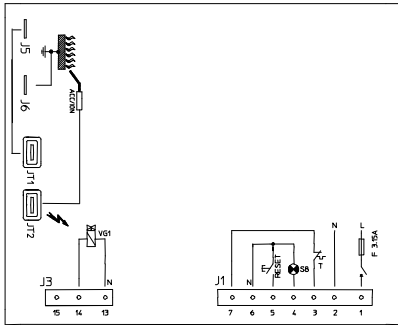

TYPE MM11F

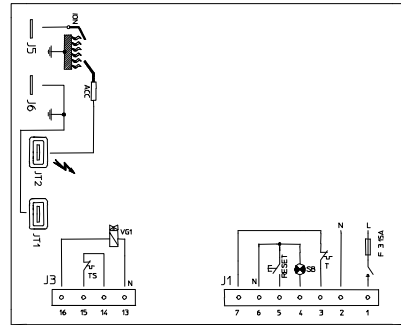

TYPE TM11F

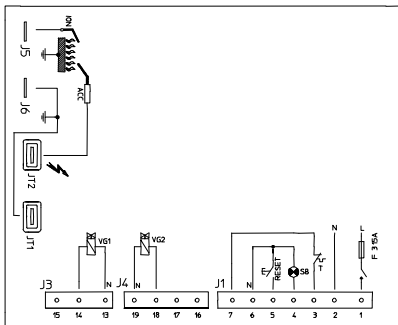

TYPE CM12F

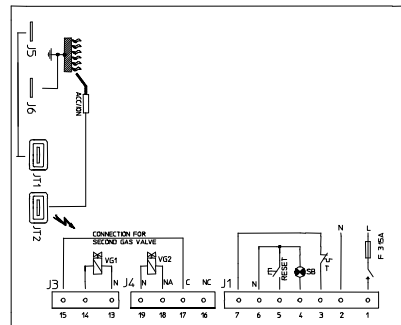

TYPE MM51F

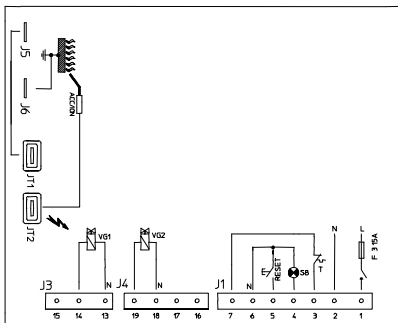

TYPE MM12F

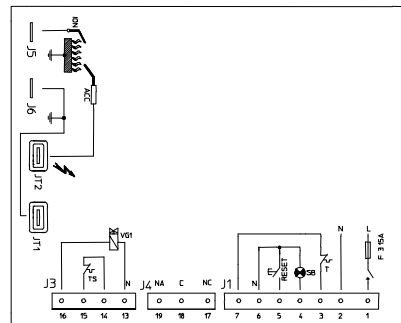

TYPE TM12F



NOTA: the limit thermostat has to be wired in series to the live.

TYPES WITH MANUAL RESET AND FAN

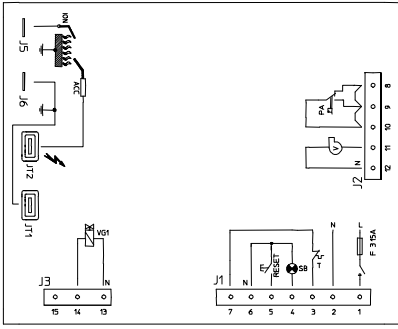

TYPE CM31F

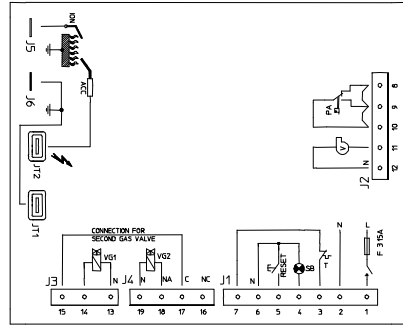

TYPE SM31F

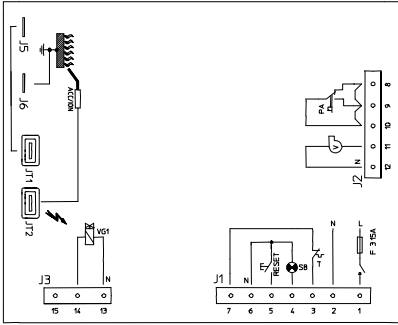

TYPE MM31F

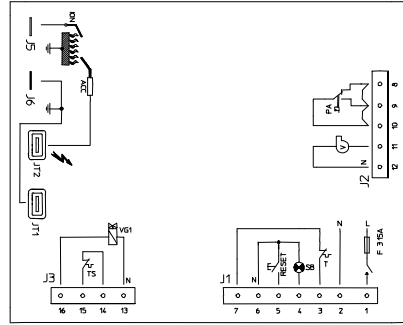

TYPE TM31F

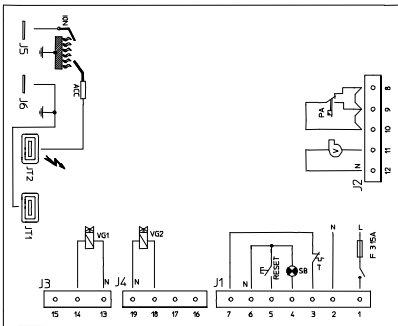

TYPE CM32F

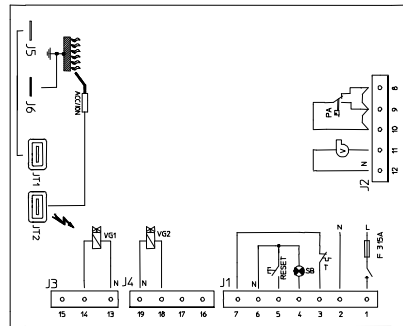

TYPE MM32F

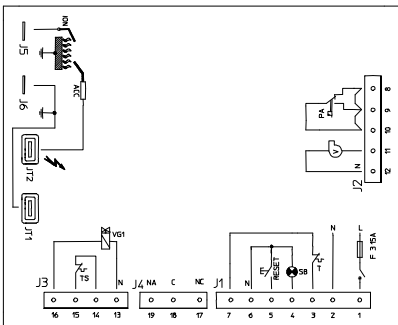

TYPE TM32F

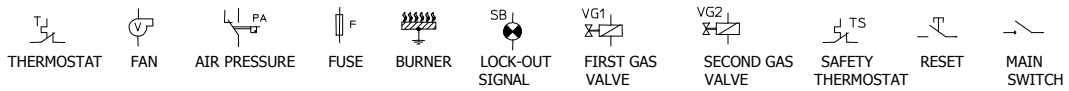

NOTA: the limit thermostat has to be wired in series to the live.

TYPES WITH ELECTRICAL RESET WITHOUT FAN

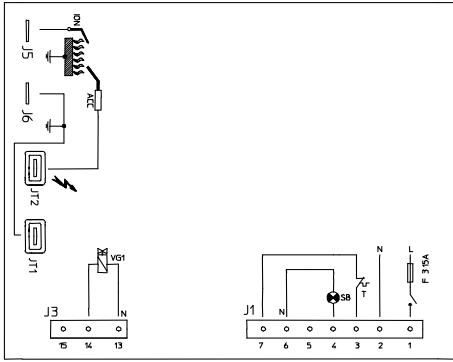

TYPE CE11F

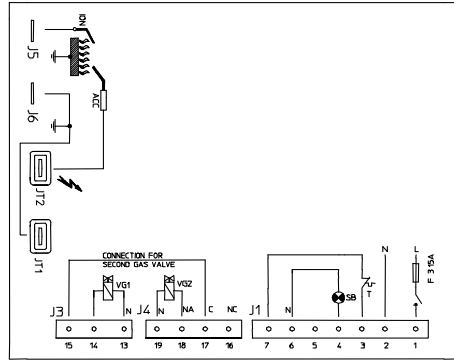

TYPE SE11F

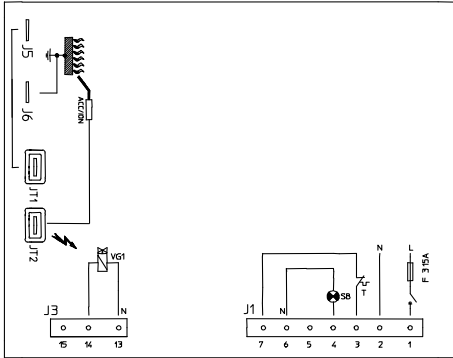

TYPE ME11F

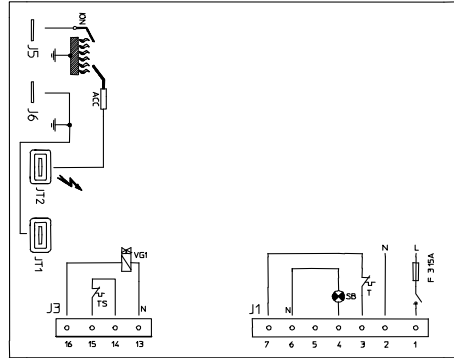

TYPE TE11F

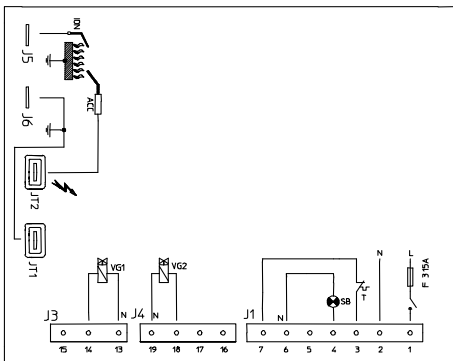

TYPE CE12F

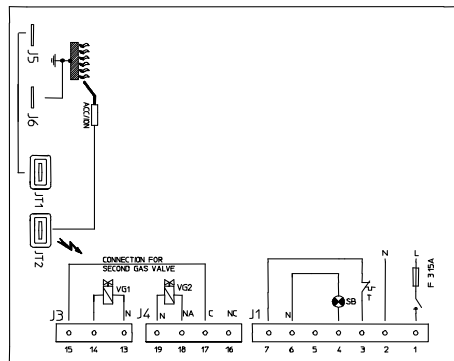

TYPE ME51F

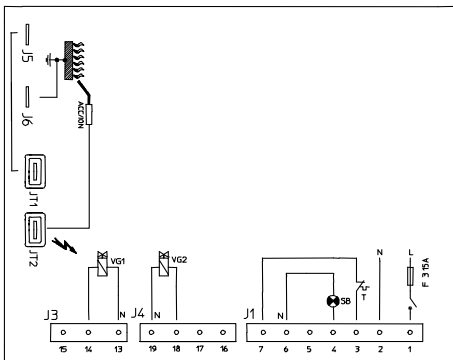

TYPE ME12F

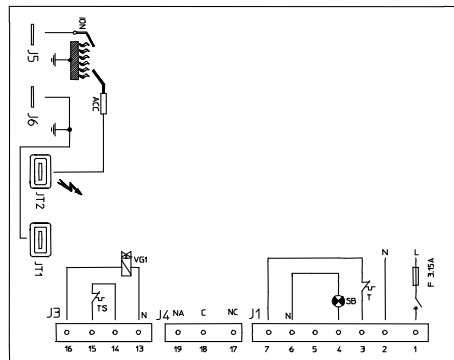

TYPE TE12F

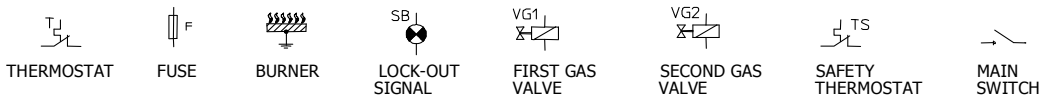

NOTA: the limit thermostat has to be wired in series to the live.

TYPES WITH ELECTRICAL RESET AND FAN

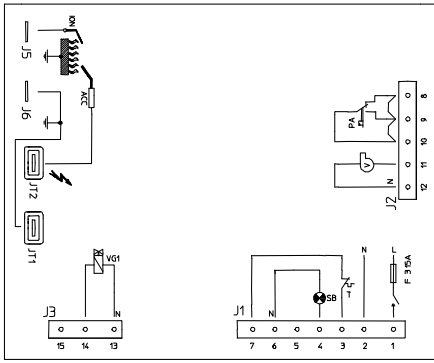

TYPE CE31F

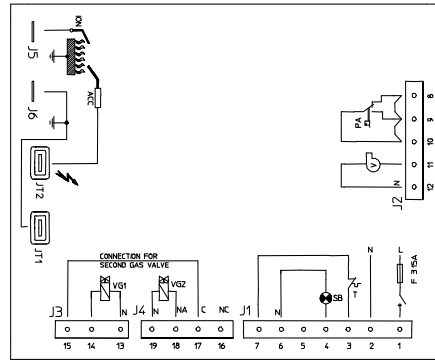

TYPE SE31F

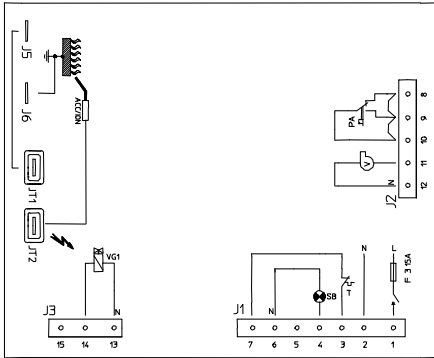

TYPE ME31F

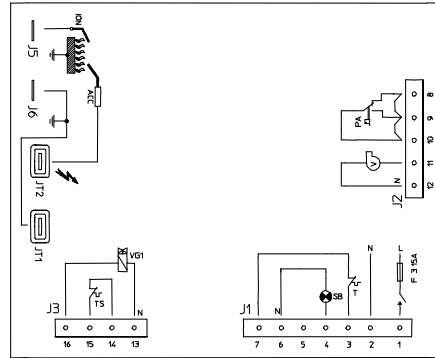

TYPE TE31F

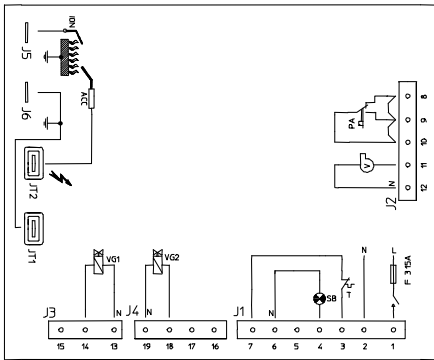

TYPE CE32F

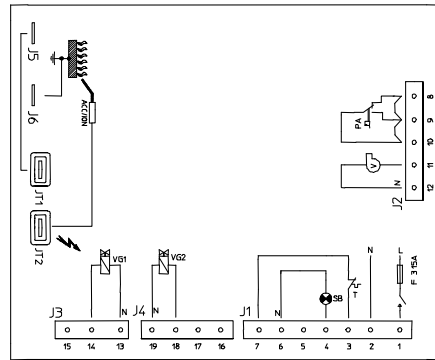

TYPE ME32F

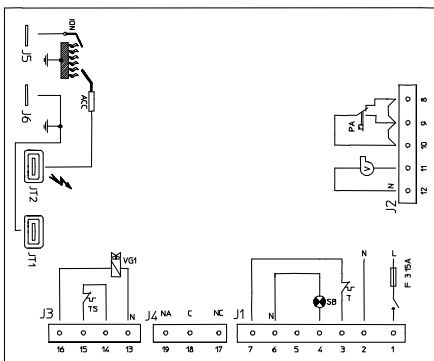

TYPE TE32F

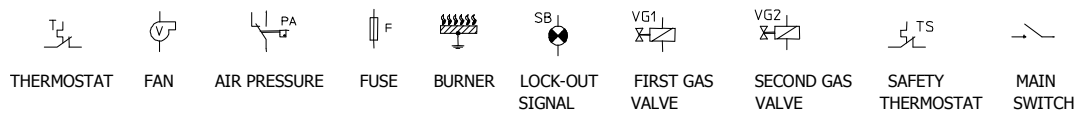

NOTA: the limit thermostat has to be wired in series to the live.

OPERATING CYCLES

TYPES WITH MANUAL RESET WITHOUT FAN

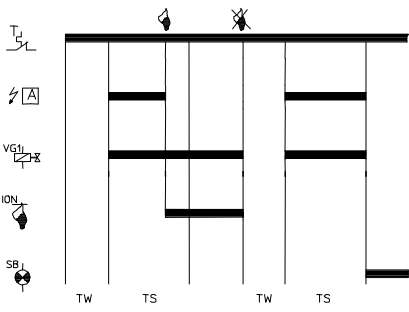

TYPE CM11F - MM11F

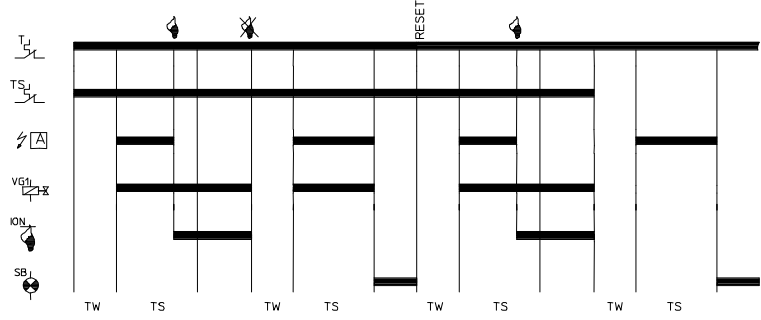

TYPE TM11F

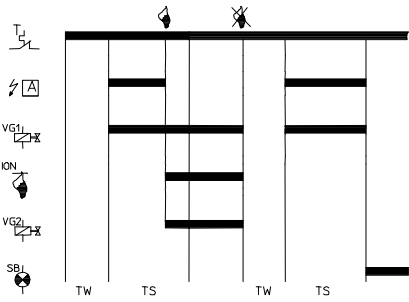

TYPE CM12F - MM12F

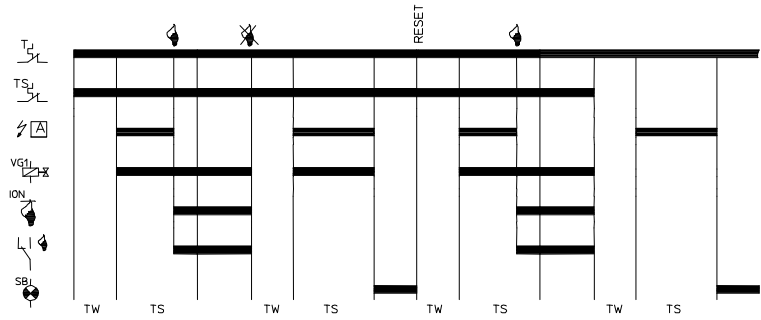

TYPE TM12F

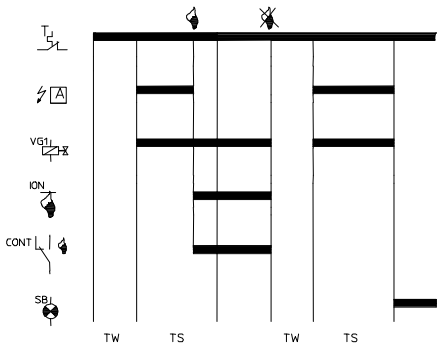

TYPE SM11F - MM51F

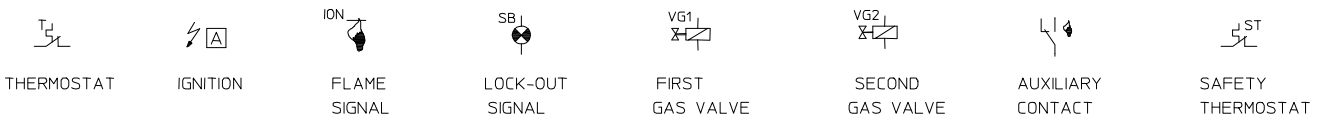

TYPES WITH MANUAL RESET AND FAN

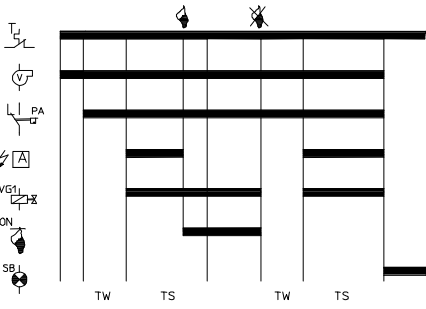

TYPE CM31F - MM31F

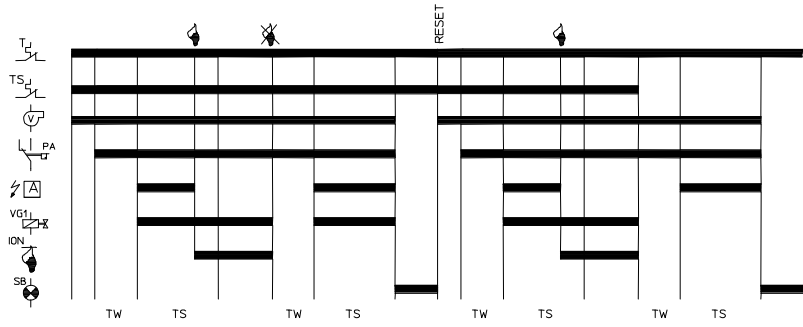

TYPE TM31F

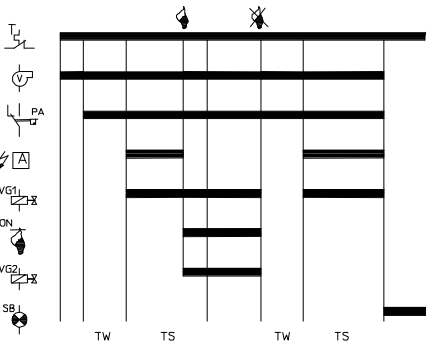

TYPE CM32F - MM32F

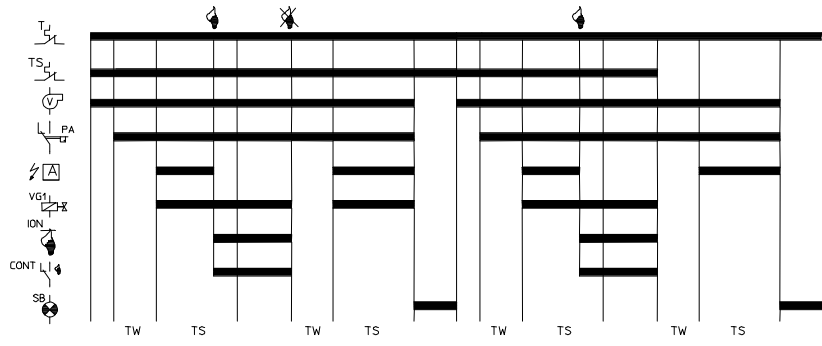

TYPE TM32F

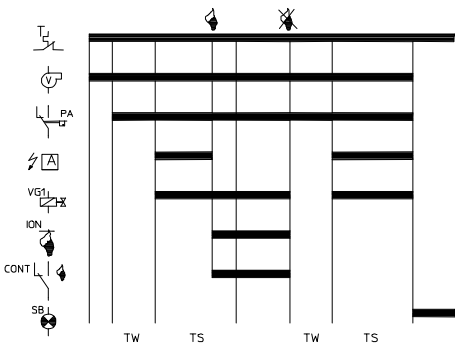

TYPE SM31F

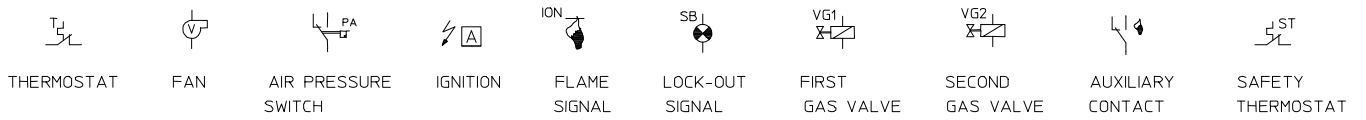

TYPES WITH ELECTRICAL RESET WITHOUT FAN

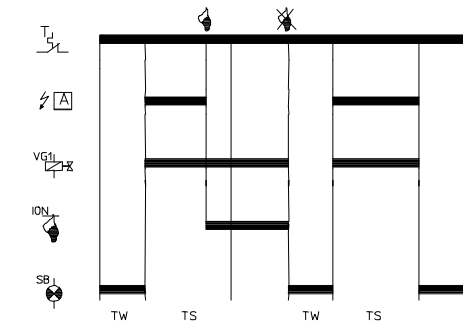

TYPE CE11F - ME11F

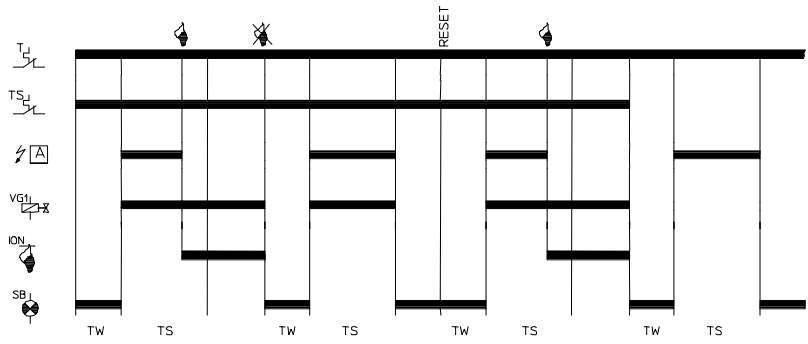

TYPE TE11F

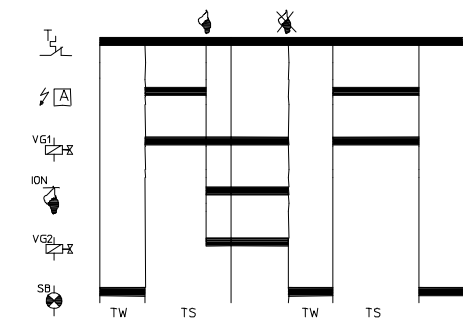

TYPE CE12F - ME12F

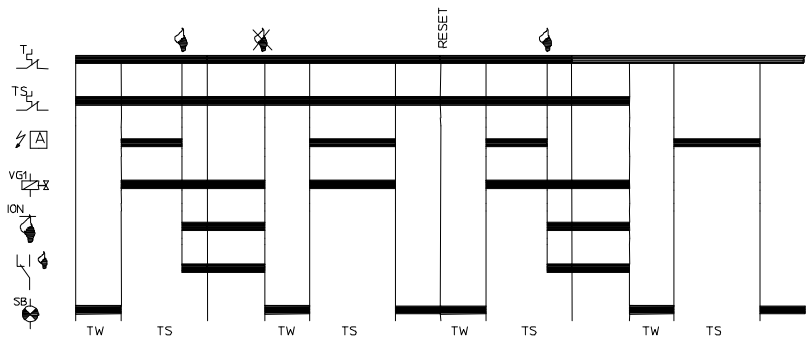

TYPE TE12F

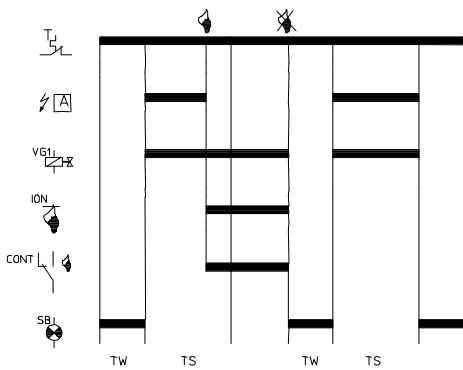

TYPE SE11F - ME51F



TYPES WITH ELECTRICAL RESET AND FAN

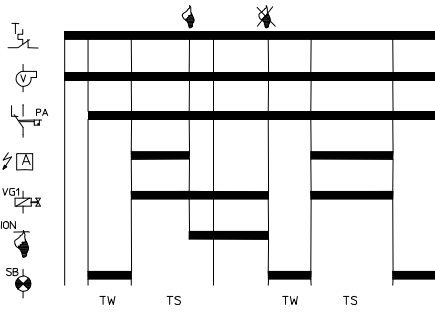

TYPE CE31F - ME31F

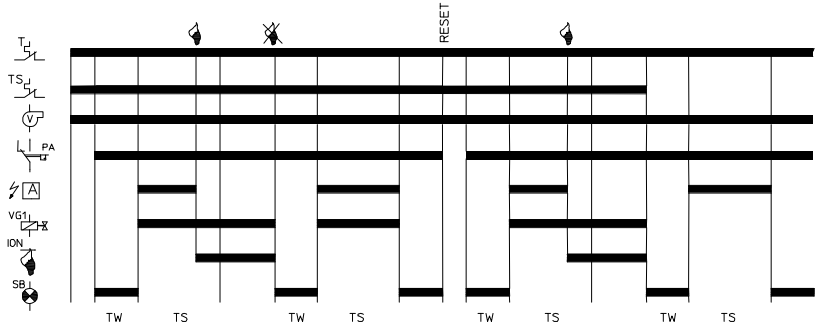

TYPE TE31F

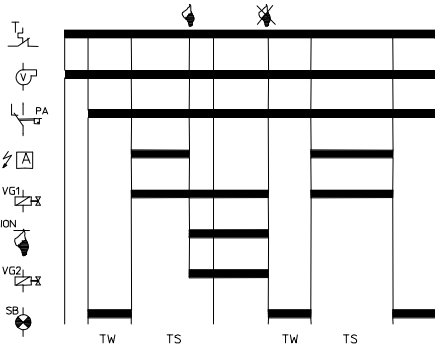

TYPE CE32F - ME32F

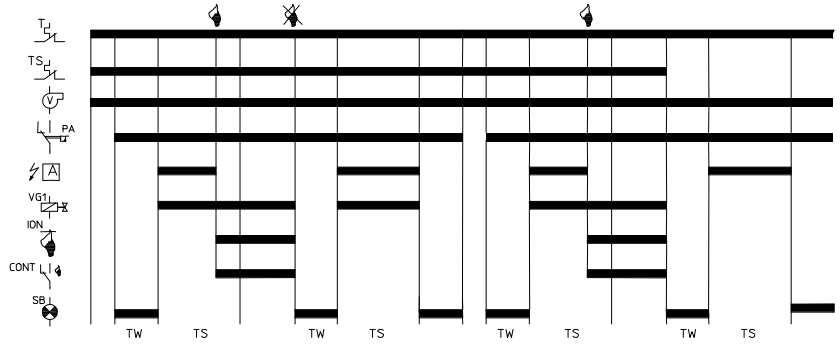

TYPE TE32F

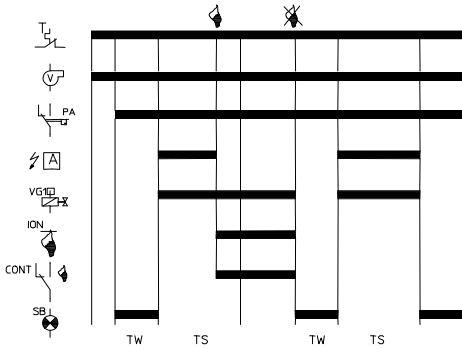

TYPE SE31F

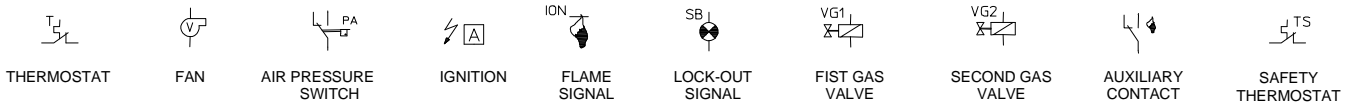

ATTENTION ->Company Brahma S.p.A. declines any responsibility for any damage resulting from the Customer's interfering with the device.

BRAHMA S.p.A.
 Via del Pontiere, 31
 37045 Legnago (VR)
 Tel. +39 0442 635211 - Telefax +39 0442 25683
<http://www.brahma.it>
 E-mail : brahma@brahma.it

07/04/04 Subject to amendments without notice